

TEST POINTS

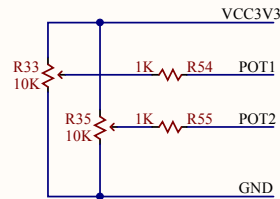
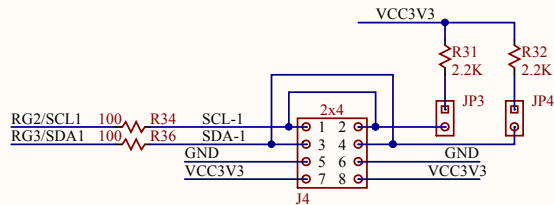
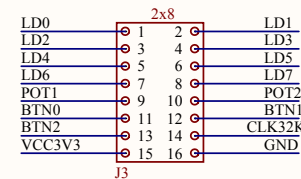
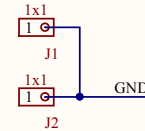

Title		Rev	
Universal Dev Board		E.0	
Circuit		Copyright 2013	
I/O AND HEADER			
Doc# 6021-500-000			
Engineer NEA			
Author GMA			
Date 4/9/2013			
Sheet# 1 out of 6			

Microchip IC

Digilent Inc.

CE

Chinese ROHS

ROHS

Foot F1

Foot F2

Foot F3

Foot F4

Foot F5

20 Pin 8-Bit PIC

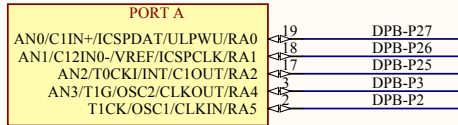

IC2A

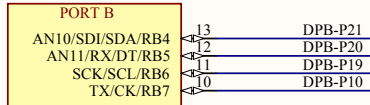

IC2B

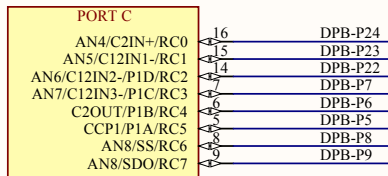

IC2C

Current Measurement

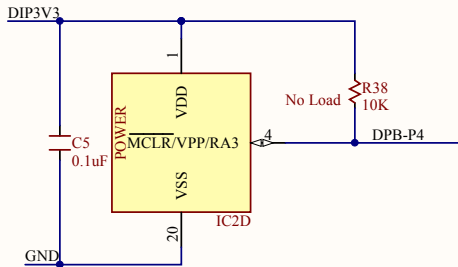
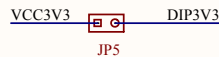

28 Pin 8-Bit PIC

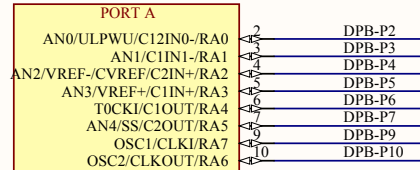

IC4A

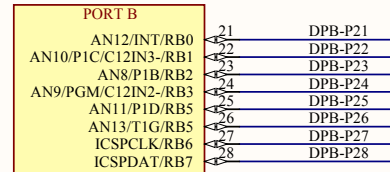

IC4B

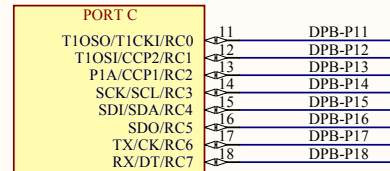

IC4C

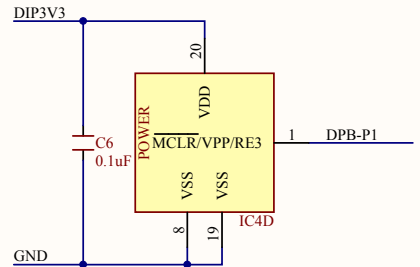

28 Pin PIC24/dsPIC33

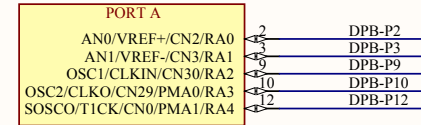

IC3A

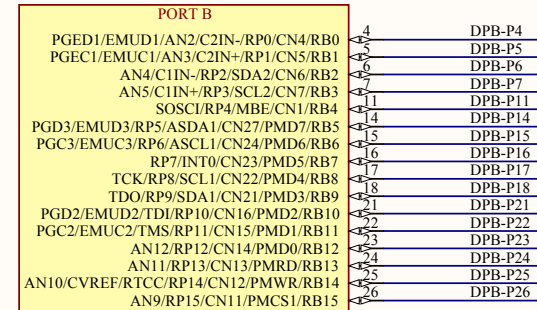

IC3B

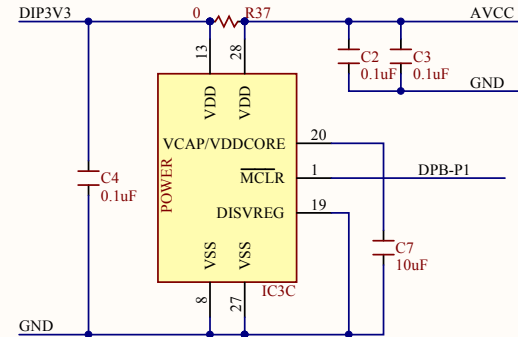

PROGRAMMING JUMPERS

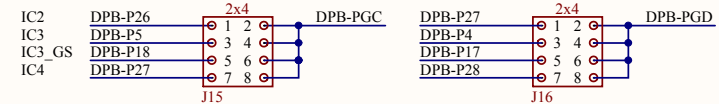

NOTE: PIC24 and dsPIC use IC3, dsPIC_GS use IC3_GS

DIP Bus Connector

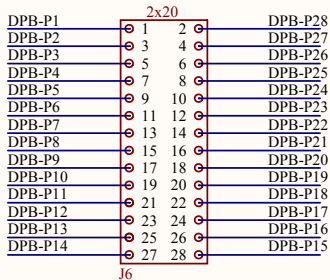

J6

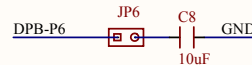

NOTE: For bypassing the internal regulator for the P18FJ24J10 Part

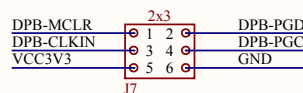

J7

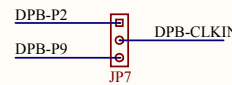
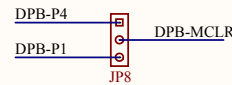

Title		Rev	
Universal Dev Board		E.0	
Circuit		Copyright 2013	
DIP MODULES			
Doc#	6021-500-000		
Engineer	NEA		
Author	GMA		
Date	4/9/2013		
Sheet#	2	out of	6

PIM Module

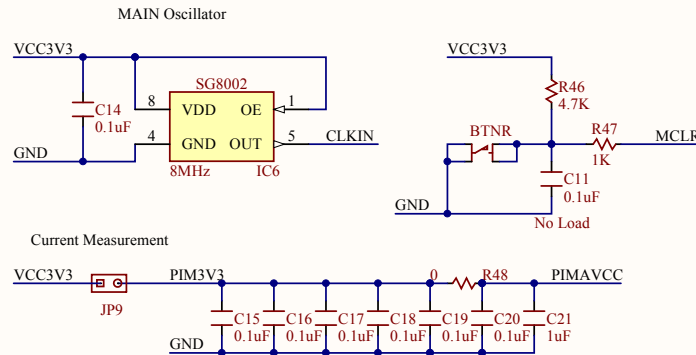
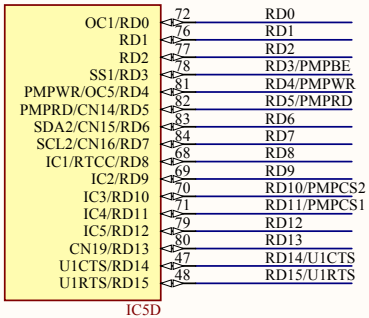
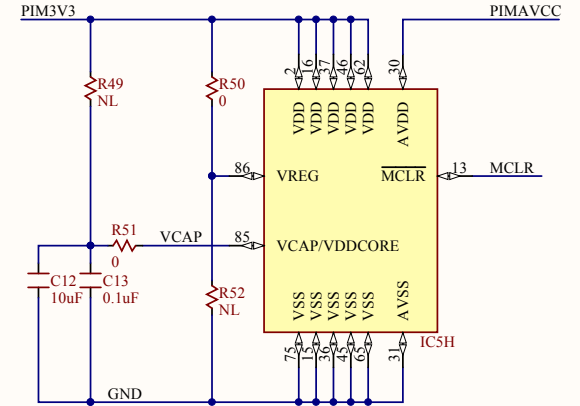
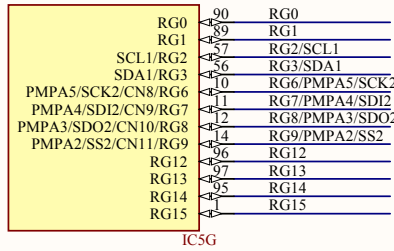
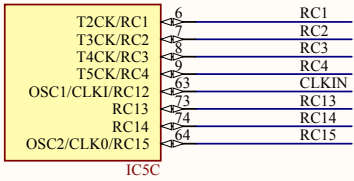
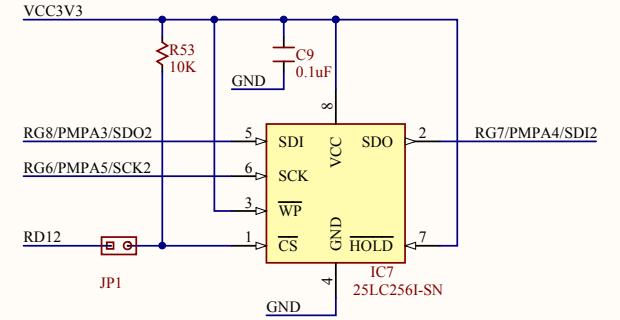
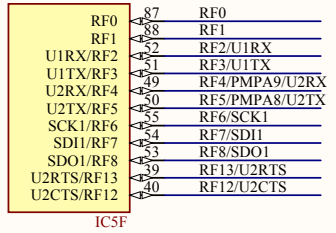
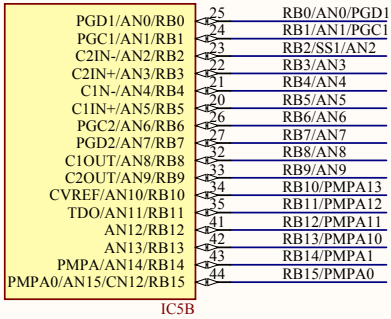
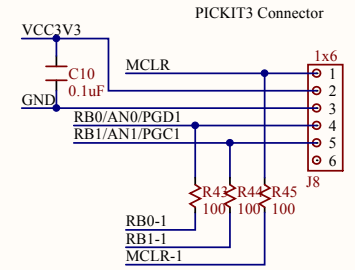
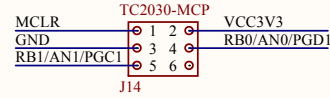
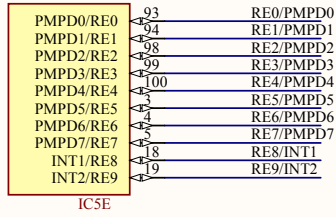
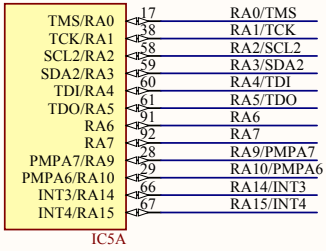

Title	Universal Dev Board	Rev	E.0
Circuit	PIM MODULE	Copyright	2013
Doc#	6021-500-000		
Engineer	NEA		
Author	GMA		
Date	4/9/2013		
Sheet#	3 out of 6		

PIC TAIL CONNECTOR

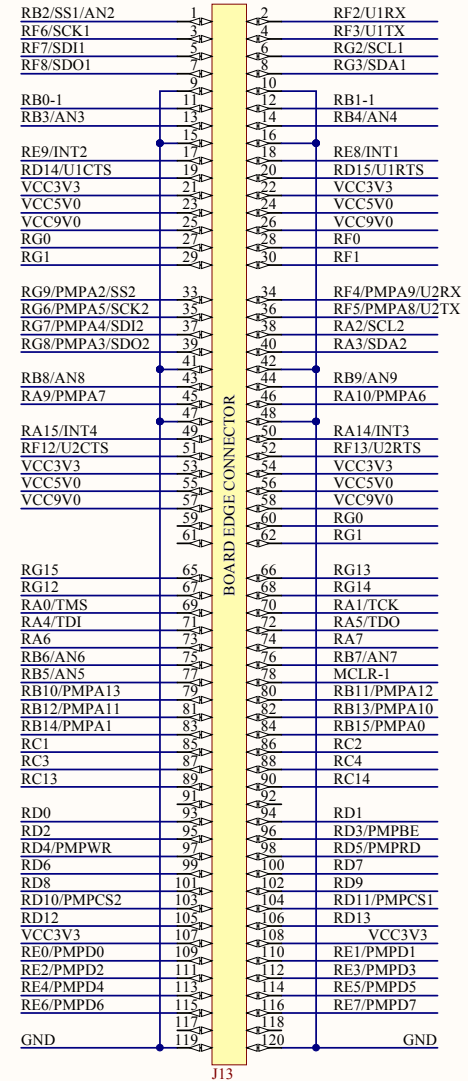
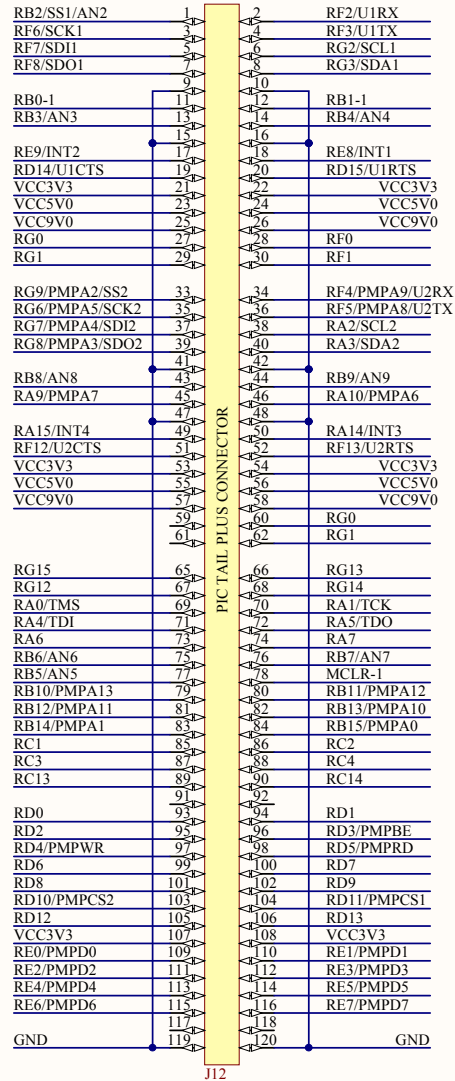
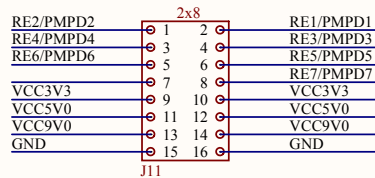
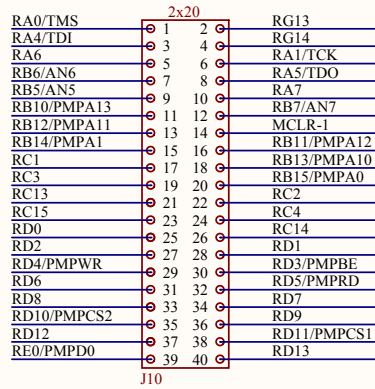
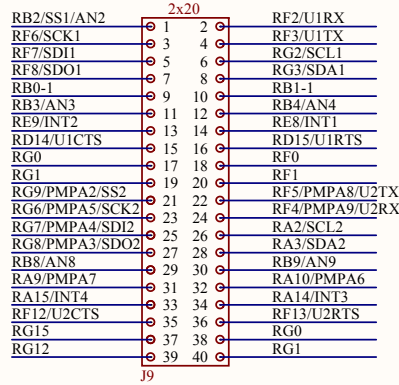

Title		Universal Dev Board		Rev	E.0
				Copyright 2013	
Circuit	EXPANSION HEADERS				
Doc#	6021-500-000				
Engineer	NEA				
Author	GMA				
Date	4/9/2013				
Sheet#	4 out of 6				



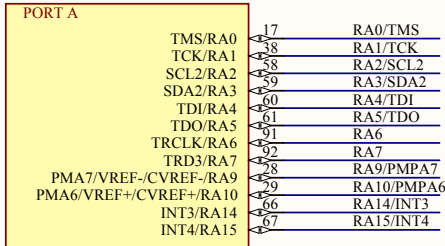

IC8A

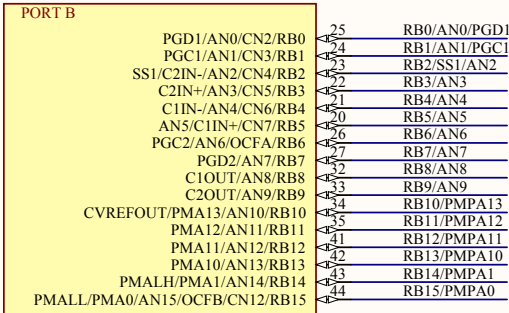

IC8B

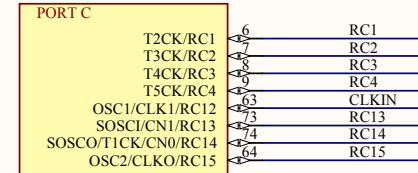

IC8C

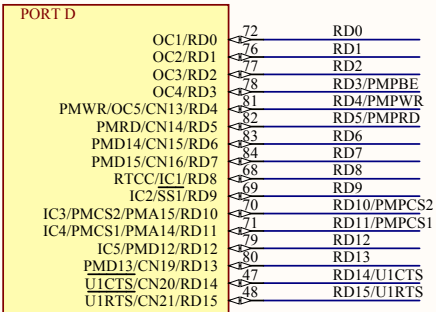

IC8D

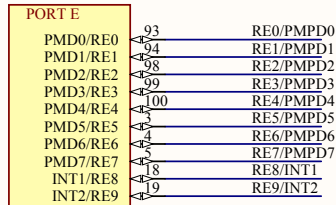

IC8E

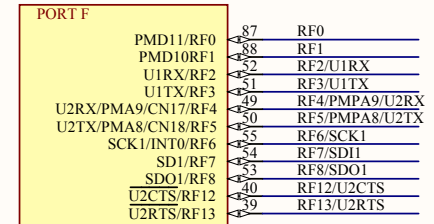

IC8F

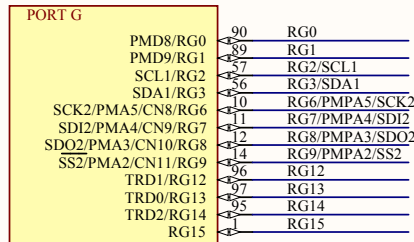

IC8G

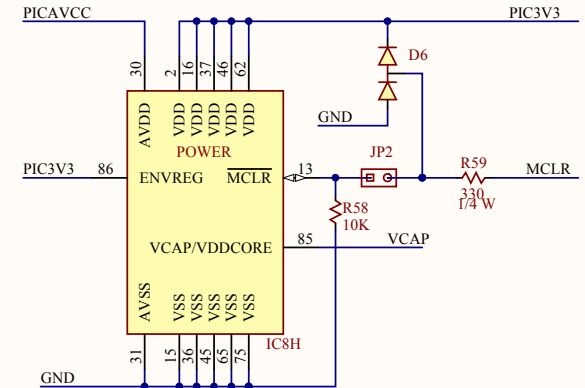

Note: When using a PICKit3 to power the UDB, it must be set to 3.3V output, otherwise disconnect JP11.

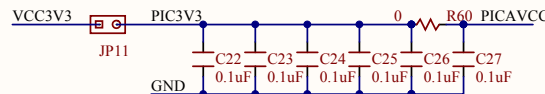

Title		Universal Dev Board		Rev	E.0
Circuit		PIC32MX360F512L		Copyright 2013	
Doc#		6021-500-000			
Engineer		NEA			
Author		GMA			
Date		4/9/2013			
Sheet#		5 out of 6			

DIGILENT
BEYOND THEORY

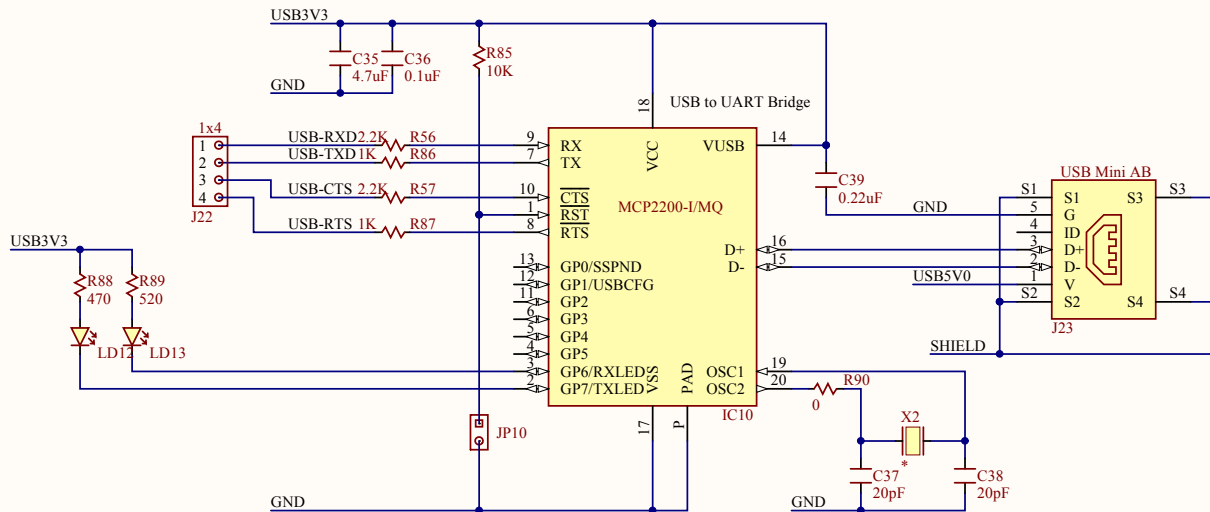
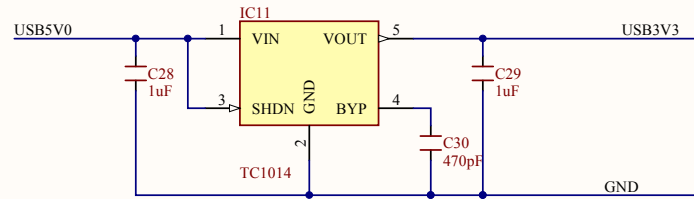
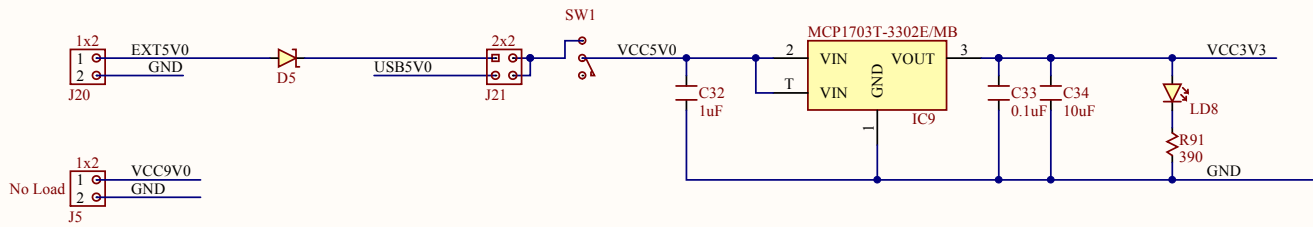

Title		Universal Dev Board		Rev	E.0
Circuit		USB and POWER		Copyright 2013	
Doc#	6021-500-000				
Engineer	NEA				
Author	GMA				
Date	4/9/2013				
Sheet#	6 out of 6				