

Port B	
PGED1/AN2/C1IND/C2INB/C3IND/RPB0/PMD0/RB0	4
PGEC1/AN3/C1INC/C2INA/RPB1/CTED12/PMD1/RB1	5
AN4/C1INB/C2IND/RPB2/SDA2/CTED13/PMD2/RB2	6
AN5/C1INA/C2INC/RTCC/RPB3/SCL2/PMWR/RB3	7
SOSCI/RPB4/RB4	11
TMS/RPB5/USBID/RB5	14
TDI/RPB7/CTED3/PMD5/INT0/RB7	16
TCK/RPB8/SCL1/CTED10/PMD4/RB8	17
TD0/RPB9/SDA1/CTED4/PMD3/RB9	18
PGED2/RPB10/D+/CTED11/RB10	21
PGEC2/RPB11/D-/RB11	22
AN11/RPB13/CTPLS/PMRD/RB13	24
CVREF/AN10/C3INB/RPB14/UBUSON/SCK1/CTED5/RB14	25
AN9/C3INA/RPB15/SCK2/CTED6/PMCS1/RB15	26

P32_PGD	4
P32_PGC	5
AN4/C1INB/C2IND/RPB2/SDA2/CTED13/PMD2/RB2	6
AN5/C2INC/RTCC/RPB3/SCL2/PMWR/RB3	7
SOSCI/RPB4/RB4	11
TMS/RPB5/USBID/RB5	14
TDI/RPB7/CTED3/PMD5/INT0/RB7	16
TCK/RPB8/SCL1/CTED10/PMD4/RB8	17
TD0/RPB9/SDA1/CTED4/PMD3/RB9	18
P32_D+	21
P32_D-	22
AN11/RPB13/CTPLS/PMRD/RB13	24
CVREF/AN10/C3INB/RPB14/UBUSON/SCK1/CTED5/RB14	25
AN9/C3INA/RPB15/SCK2/CTED6/PMCS1/RB15	26

IC1PORT\_B

Port A	
PGED3/UREF+/CVREF+/AN0/C3INC/RPA0/CTED1/PMD7/RA0	2
PGEC3/UREF-/CVREF-/AN1/RPA1/CTED2/PMD6/RA1	3
OSC1/CLK1/RPA2/RA2	9
OSC2/CLK0/RPA3/PMA0/RA3	10
SOSCO/RPA4/T1CK/CTED9/PMA1/RA4	12

PGED3/UREF+/CVREF+/AN0/C3INC/RPA0/CTED1/PMD7/RA0	2
PGEC3/UREF-/CVREF-/AN1/RPA1/CTED2/PMD6/RA1	3
OSC1/CLK1/RPA2/RA2	9
OSC2/CLK0/RPA3/PMA0/RA3	10
SOSCO/RPA4/T1CK/CTED9/PMA1/RA4	12

IC1PORT\_A

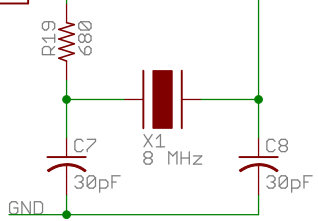

SILK No Load

PGED3/UREF+/CVREF+/AN0/C3INC/RPA0/CTED1/PMD7/RA0	9
PGEC3/UREF-/CVREF-/AN1/RPA1/CTED2/PMD6/RA1	10
P32_PGD	11
P32_PGC	12
AN4/C1INB/C2IND/RPB2/SDA2/CTED13/PMD2/RB2	13
AN5/C2INC/RTCC/RPB3/SCL2/PMWR/RB3	14
OSC1/CLK1/RPA2/RA2	15
OSC2/CLK0/RPA3/PMA0/RA3	16
SOSCI/RPB4/RB4	17
SOSCO/RPA4/T1CK/CTED9/PMA1/RA4	18
UTN	19
UCC3U3	20
GND	21

J3

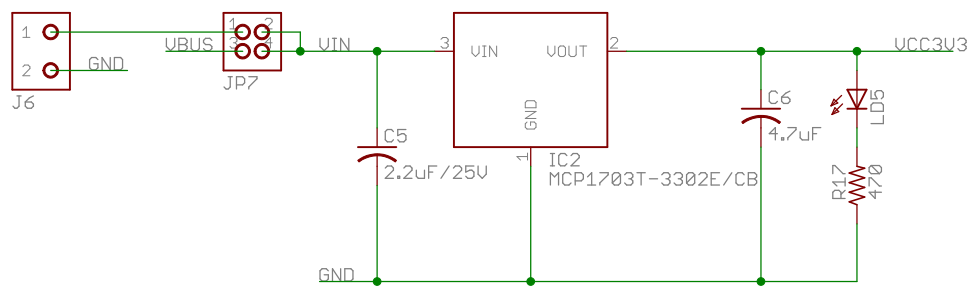

No Load

TMS/RPB5/USBID/RB5	0
TDI/RPB7/CTED3/PMD5/INT0/RB7	1
TCK/RPB8/SCL1/CTED10/PMD4/RB8	2
TD0/RPB9/SDA1/CTED4/PMD3/RB9	3
P32_D+	4
P32_D-	5
AN11/RPB13/CTPLS/PMRD/RB13	6
CVREF/AN10/C3INB/RPB14/UBUSON/SCK1/CTED5/RB14	7
AN9/C3INA/RPB15/SCK2/CTED6/PMCS1/RB15	8
UTN	9
UCC3U3	10
GND	11
GND	12
GND	13

J4

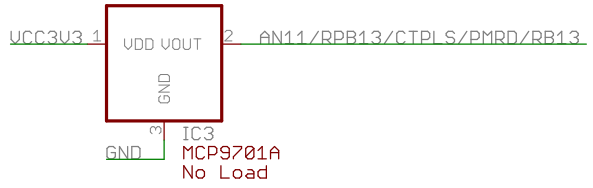

chipKIT DP32		Engineer: NEA
Copyright 2013, Digilent Inc.		Author: PJA/CLG
SHEET: Microcontroller / Power		Rev: C.0
TITLE: chipKIT DP32		Date: 11/07/2013
Doc#: 500-280	Date: 11/07/2013	Sheet: 1/2

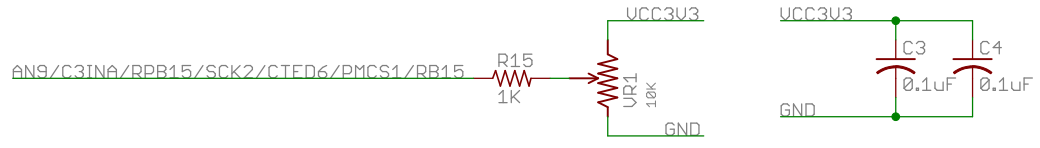
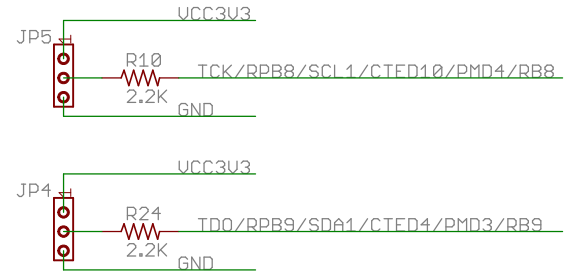
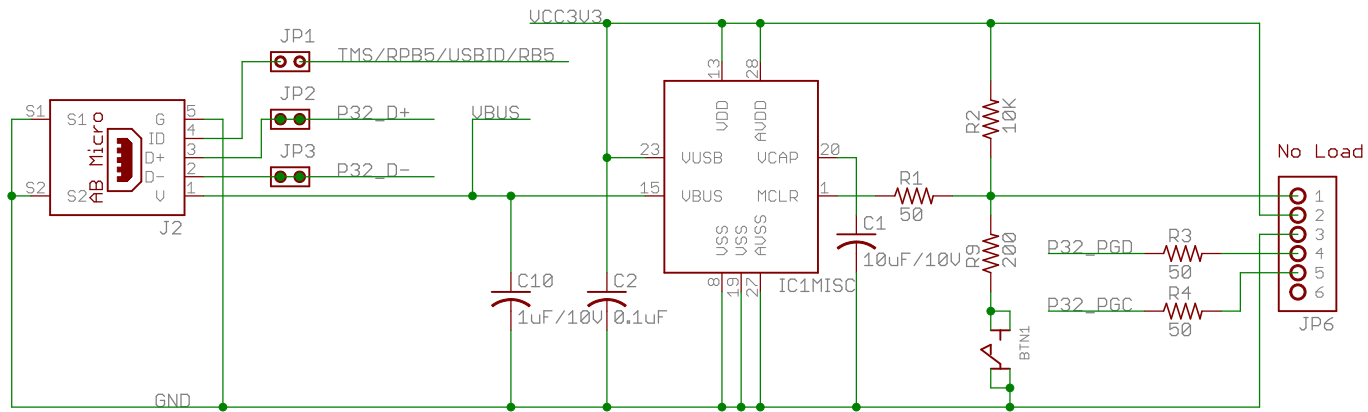
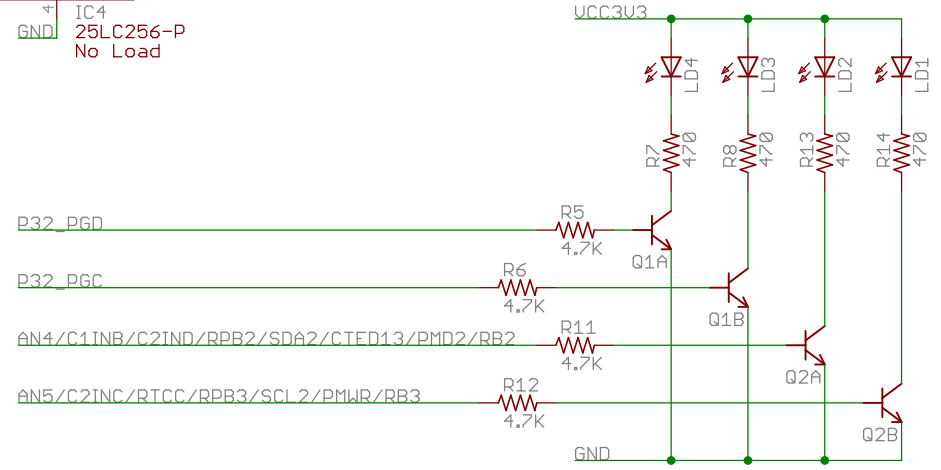
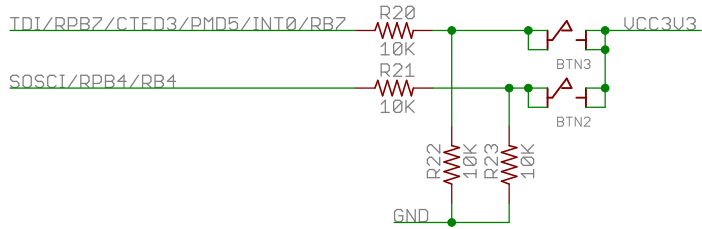
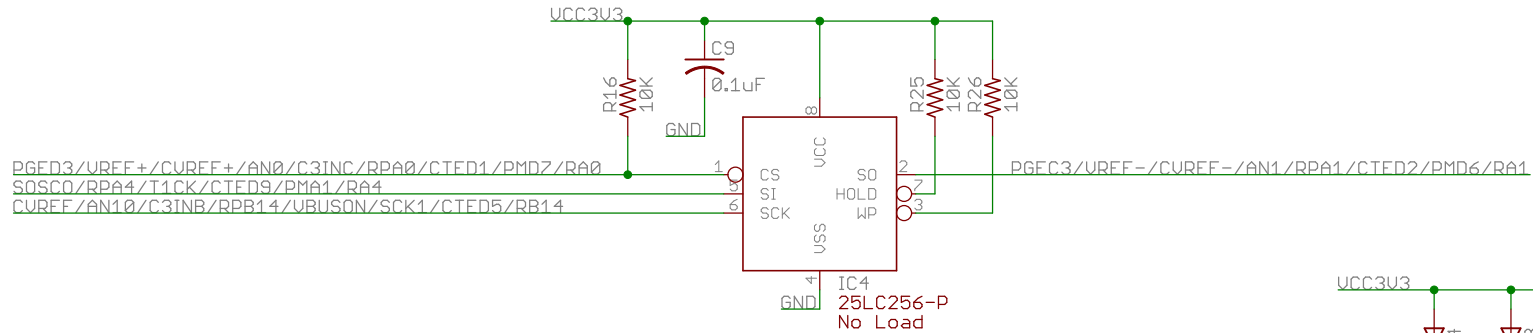

chipKIT DP32		Engineer: NEA
Copyright 2013, Digilent Inc.		Author: PJA/CLG
SHEET: Peripherals		Rev: C.0
TITLE: chipKIT DP32		Doc#: 500-280
Date: 11/07/2013	Sheet: 2/2	